

FAG



FAG SmartCheck

User manual

SCHAEFFLER



Imprint

FAG Industrial Services GmbH
Kaiserstraße 100
52134 Herzogenrath
Germany
Telephone: +49 (0) 2407 9149 66
Fax: +49 (0) 2407 9149 59
Email: industrial-services@schaeffler.com
Webside: www.schaeffler.com/services

All rights reserved.

No part of the documentation or software may be reproduced in any form or processed, duplicated or distributed using electronic systems without our written consent. We would like to point out that the designations and brand names of the various companies used in the documentation are generally protected by trademark, brand and patent laws.

Microsoft, Windows and Internet Explorer are brands or registered trademarks of the Microsoft Corporation in the USA and/or in other countries. Firefox is a trademark of the Mozilla Foundation. Loctite is a trademark of Henkel AG.

The software uses the following third-party provider libraries under their respective licences:
at91bootstrap, busybox, busybox-config, dropbear, expat, gdb, gettext, kexec-tools, kiss_fft, kmod, libcurl, libidn, libmodbus, libunwind, linux

Full licence conditions for the respective libraries can be found in the software's program directory.

Version 1.12.0

Translation of the original user guide.

© 09/06/2017 - FAG Industrial Services GmbH

Contents

1	General.....	4
1.1	Safety information.....	4
1.2	Hazard symbols and signal words.....	4
1.3	About this guide.....	5
2	Product description.....	6
2.1	Intended use.....	6
2.2	Modifications by the user.....	7
2.3	Technical data.....	7
2.4	Scope of delivery.....	8
3	Installation.....	9
3.1	Installation site and materials required.....	9
3.2	Dimensions.....	10
3.3	Installing the device directly on a component.....	11
3.4	Installing the device on a sensor mounting plate.....	12
4	Set-up.....	14
4.1	Connection overview.....	15
4.2	Connection details.....	16
4.3	Connecting inputs and outputs.....	18
4.3.1	Connection configuration: Digital speed signal	18
4.3.2	Connection configuration: Analogue speed signal	20
4.3.3	Connection configuration: Analogue output signal	22
4.3.4	Connection configuration: Digital output signal	23
4.4	Connecting PC/Ethernet.....	25
4.5	Connecting the power supply.....	25
4.6	Connecting multiple devices.....	27
5	Operation and controls.....	29
5.1	Reset and Teach buttons.....	31
6	Further information.....	33
7	Maintenance and repair.....	35
8	Decommissioning and disposal.....	36
9	Manufacturer / Support.....	37
10	Appendix.....	38

1 General

1.1 Safety information

The FAG SmartCheck vibration monitoring system is manufactured in accordance with the recognised standards and guidelines (see Declaration of Conformity) and is safe to operate. Nevertheless, the device can pose unavoidable residual hazards to users and third parties or to property, therefore it is imperative that all of the safety information given in this guide is observed. The generally applicable safety and accident prevention regulations must also be taken into account. Failure to do so may result in the health and life of persons being put at risk, or cause damage to property. The safety information in this guide applies in the Federal Republic of Germany. In other countries, the relevant national regulations apply.



According to its intended use, the SmartCheck device is not subject to EC Machine Directive 2006/42/EC.

This guide differentiates between

- **General safety information**, which applies to the whole guide and is listed in this chapter and
- **Specialised safety information**, which you will find in each chapter, either at the start or accompanying individual actions

General safety information

FAG SmartCheck is integrated in a machine as a system for permanent machine monitoring. The system must be installed in the machine, connected to machine components and operated in the machine within the specifications set out in this guide (see Technical data ⁽⁷⁾). The machine owner is responsible for installing the device properly and for ensuring safe operation in the machine as a whole.

In addition to recording measured values, it is also possible to transfer characteristic values or alarms to superordinate control systems via the SmartCheck outputs. In doing so, the limitations of use for the connected machine components must also be observed, in addition to the SmartCheck specification. The machine owner bears sole responsibility for this.



The FAG SmartCheck device must not be used for safety-relevant tasks or for critical switching operations! This applies in particular when these tasks or switching operations have health and safety implications.

Operating personnel

SmartCheck may only be installed, operated and maintained by authorised qualified electricians who have received training in accordance with the applicable, relevant regulations.

1.2 Hazard symbols and signal words

Hazard symbols used in this guide

Safety information and warnings are identified by specific, standardised hazard symbols. If no specific symbol applies, a general hazard symbol is used.

General hazard symbol

DANGER



The nature and source of the hazard are specified here

Actions to prevent the hazard are explained here.

Specific hazard symbols

DANGER



DANGER FROM ELECTRICAL CURRENT!

This symbol indicates a danger from electric shock that can cause personal injury or even death, or damage to property.

Signal words used in this guide

Signal words indicate the severity of the hazard that occurs if the actions to reduce the hazard are not taken.

- **Caution:** Minor damage to property may occur.
- **Warning:** Minor personal injury or severe damage to property may occur.
- **Danger:** Personal injury may occur. There is a risk of fatal injury in particularly severe cases.

1.3 About this guide

This guide describes the installation and use of the FAG SmartCheck device and contains important information about using the device safely and correctly. Please read through this guide carefully before commissioning the device, and keep it for future reference.

Make sure that

- This guide is available to all users of the device.
- If the product is passed on to other users, that this guide is also passed on with it.
- Additions and amendments provided by the manufacturer are always attached to this guide.

Further information

In addition to the device described in this guide, the FAG SmartCheck vibration monitoring system also includes the integrated FAG SmartWeb software, which is dealt with in a separate manual.

To operate the FAG SmartCheck device, you will also need the supplied FAG SmartUtility Light software. This is also dealt with in a separate manual. You also have the option of purchasing the FAG SmartUtility software, which features enhanced functionality.

Definitions

- **Product:** The FAG SmartCheck device described in this manual.
- **User:** person or organisation capable of putting the product into operation and using it.
- **Qualified person:** a person who, by virtue of their relevant training and experience, is qualified to identify risks and avoid potential hazards that may be caused by the operation or maintenance of a product.

Symbols used



This symbol indicates

- *Helpful additional information and*
- *Device settings or practical tips that will help you to perform activities more efficiently.*

Cross-reference symbol : this symbol refers to a page in the manual that provides further information. If you are reading the manual in PDF format on a screen, clicking the word to the left of the cross-reference symbol will take you straight to the section in question.

2 Product description

About the FAG SmartCheck system

FAG SmartCheck is a vibration monitoring system for permanent frequency-selective monitoring. Other measurements can be captured, recorded and analysed using two integrated signals and up to three connected signals. After the analysis, the system can switch outputs and display the status using LEDs depending on user-defined alarm limits.

Inputs are available, which record additional signals, to allow the device to be integrated into a superordinate system. These signals can be used as command variables for a dependent signal analysis, e.g. to initiate time or event-controlled measurement tasks.

The FAG SmartCheck device can be used to cover a wide range of applications; the SmartCheck device can be configured to meet your own requirements using the integrated web application and FAG SmartWeb software. Multiple SmartCheck devices can be combined in a network. Regardless of the number of devices, they can be managed centrally on a PC using the FAG SmartUtility software.

With FAG SmartCheck, Schaeffler offers status monitoring that is optimised to suit your requirements.



The SmartCheck device is ready for measurement as soon as the power supply is connected. To ensure optimum vibration monitoring from the outset, we recommend that you do not start the SmartCheck device until

- All connections have been correctly made, and
- The machine to be monitored is in a normal operating state

2.1 Intended use

The FAG SmartCheck device is intended solely for:

- Capturing and analysing vibration measurement signals
- Capturing temperature signals
- Evaluating signals entering the device at its inputs

The FAG SmartCheck device may only be operated within the limitations of use specified in the Technical data [\[7\]](#).

Measured-value analyses and changes to settings may only be made using the supplied FAG SmartUtility Light software, the optional FAG SmartUtility software, the integrated FAG SmartWeb software or, where possible, on the device itself.

Any other or additional use of the device is deemed to be not intended; the user bears sole risk for such use. The user is responsible for the intended use of the device. This also includes observing this guide.

2.2 Modifications by the user

The user must not make any modifications to the FAG SmartCheck device. The user may only make settings on the device itself or via the FAG SmartWeb or FAG SmartUtility Light/FAG SmartUtility software.

The user bears responsibility for any further modifications! Should you detect a fault with your FAG SmartCheck device, please contact our Support team.

2.3 Technical data



- *The SmartCheck device must not be used in measurement voltage categories II, III or IV!*
- *Cover any M12 connections that are not in use with the plugs supplied. This is the only way to ensure that the degree of protection is maintained.*

Internal sensors	
Vibration	Acceleration sensor (piezoelectric sensor) Frequency range: 0.8 Hz–10 kHz Measurement range: ± 50 g
Temperature	Measurement range: -20 to +70°C
Measurement	
Measurement functions	Acceleration Speed and path by integration System temperature Process parameters (e.g. speed, load, pressure)
Diagnostic methods	Time signal, demodulation, spectrum and trend analysis, speed and frequency tracking
Characteristic values (time range and frequency range)	
Defined characteristic values	DIN/ISO 10816
Calculated characteristic values	RMS, frequency-selective RMS, constant component, peak, peak-to-peak, crest factor, Wellhausen count, carpet level, condition guard Other user-defined characteristic values are possible.
Signal processing	
Frequency resolution	1600, 3200, 6400 or 12800 lines Min. line width 0.0039 Hz at 50 Hz (depending on low-pass)
Measurement resolution	24 bit (A/D converter)
Frequency range	0.8 Hz–10 kHz
Low-passes	50 Hz–10 kHz (50 Hz, 100 Hz, 200 Hz, 500 Hz, 1 kHz, 2 kHz, 5 kHz, 10 kHz)
High-passes (demodulation only)	750 Hz, 1 kHz, 2 kHz (other filters on request)
Memory	
Program and data	64 MB RAM, 128 MB flash
Inputs and outputs	
Inputs	2 analogue inputs (0-10 V/0-24 V/0-20 mA/4-20 mA), frequency range 0-500 Hz, 12 bit 1 digital input (0-30 V, 0.1 Hz-1 kHz)
Outputs	1 analogue output (0-10 V/0-20 mA/4-20 mA), 12 bit 1 switching output (open collector, max. 1 A, 28 V) Optional galvanic isolation between inputs and outputs
Interfaces	
Control elements	2 capacitive buttons (learning mode, alarm reset, restart, factory settings)
Display elements	1 LED for displaying the status and alarms 1 LED for confirming buttons 2 LEDs for displaying communication
Communication	Ethernet 100 Mb/s RS485 (not currently supported)

Electrical connections	3 reverse-polarity protected M12 plug connectors for supply, RS485, inputs/outputs and Ethernet
Miscellaneous	
Housing	Glass fibre reinforced plastic
Fixing	M6x45 hex socket head screw Support area on machine: 25 mm Ø
Power consumption	<200 mA at 24 V
Ambient temperature	-20 to +70°C
Internal operating temperature	-20 to +85°C
Power supply	16 - 32 VDC or Power over Ethernet (PoE) pursuant to 802.3af Mode A
Dimensions	44 mm x 57 mm x 55 mm
Weight	Approx. 210 g
Protection type	IP 67
Operating system	Embedded Linux
Software	FAG SmartWeb (Mozilla Firefox ESR 45 (recommended), Internet Explorer 11, Internet Explorer 9 is not recommended for performance reasons) FAG SmartUtility Light or optionally FAG SmartUtility Languages: German, English, Chinese, Spanish, French, Japanese



Subject to technical modifications!

2.4 Scope of delivery

Scope of delivery

- FAG SmartCheck device with integrated FAG SmartWeb software
- User documentation for FAG SmartCheck and FAG SmartWeb on CD-ROM
- FAG SmartUtility Light software with user documentation on CD-ROM
- 1 fixing screw: M6x45 hex socket head screw
- 1 O-ring to secure the fixing screw in position
- 1 plug with logo to cover the mounting aperture
- 3 plugs to cover unused M12 connections



The standard scope of delivery for the FAG SmartCheck device does not include any cables for connecting the device.

Optional accessories

An extensive range of optional accessories for the FAG SmartCheck is available from FAG Industrial Services GmbH:

- SmartUtility software with user documentation on CD-ROM; this software features enhanced functionality compared with the SmartUtility Light software
- M6 sensor mounting plate for mounting the SmartCheck device (stainless steel 1.4301)
- Power cable for SmartCheck; 8-pin M12 socket on a free cable end
- Ethernet cable for SmartCheck; M12 connector on RJ45
- Input/output connection cables; 8-pin M12 connector on free cable end
- M12 Y-splitter to facilitate wiring the power supply to multiple SmartCheck devices

Further information is available from your customer support representative (see Support).

3 Installation

The following sections contain important details about setting up the FAG SmartCheck device on a machine that you wish to monitor.



Ensure that the device is free from damage prior to installation.

In case of doubt, consult a qualified electrician or contact your customer support representative at FAG Industrial Services GmbH.

3.1 Installation site and materials required

Installation site

To install the SmartCheck device, select a site with optimum vibration transfer. To monitor a bearing for example, this would be near the roller bearing you wish to monitor and radial to the axis of rotation. It is recommended to consult a vibration expert for this step to ensure optimum condition monitoring. FAG Industrial Services GmbH offers a service that is tailored to your specific requirements. Further details about this can be obtained from your customer support representative (see Support).

Please also note the following points:

- The SmartCheck device must be mounted vertically in relation to the installation surface.
- The installation surface must not be curved or uneven.
- The surface should exhibit a mean roughness index of $R_a = 3.2 \mu\text{m}$ and should be free from impurities.
- The SmartCheck device can be operated at ambient temperatures from -20°C to $+70^\circ\text{C}$

Installation type

To ensure the SmartCheck device is installed safely and permanently, it should be mounted on the machine and/or component that you wish to monitor.

The device can be screwed directly into a hole on the component. To do this, you will need to drill a tapped hole at least 9 mm deep at the selected position; the surface must exhibit a mean roughness index of $R_a = 3.2 \mu\text{m}$.

If this is not possible, you can bond an M6 sensor mounting plate to the installation surface and then screw the device to the mounting plate. The sensor mounting plate is available as an optional accessory from FAG Industrial Services GmbH.

Materials

The following materials are also required to install the SmartCheck device:

- Tool for creating the tapped M6 hole or an M6 sensor mounting plate including an adhesive suitable for vibration measurement (e.g. Loctite 330)
- Some lubricant (oil, grease)
- Offset screwdriver for M6 hex socket head screw
- A torque wrench (tightening torque 10 Nm) with socket for a 6-mm hex socket head screw

Optional items:

- Vibration-resistant screw locking compound (e.g. Loctite 243 medium-strength threadlocker)
- Cable ties for securing the cable

3.2 Dimensions

The following illustrations show the SmartCheck device from different perspectives with dimensions accurate to the millimetre.

Basic dimensions from the front

This front view shows the connections of the SmartCheck device as well as the fixing screw protruding downward and the sensor area.

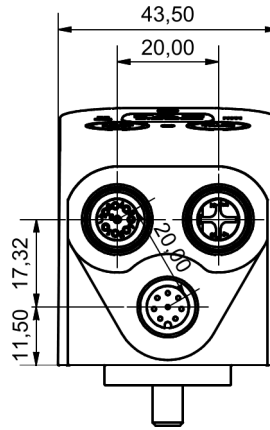

Basic dimensions from the side

The side view shows the angled surface of the SmartCheck device; you can also see how far the connections protrude and how the sensor area is dimensioned.

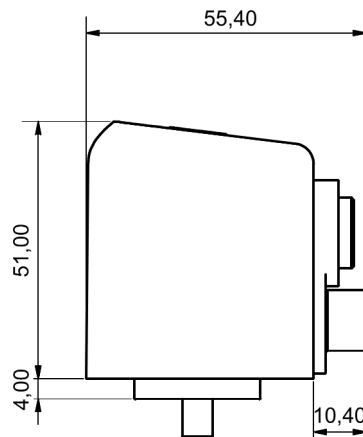

Basic dimensions in cross-section

The open cross-section affords a view into the mounting aperture of the SmartCheck device and shows the dimensions of the fixing screw and sensor area.

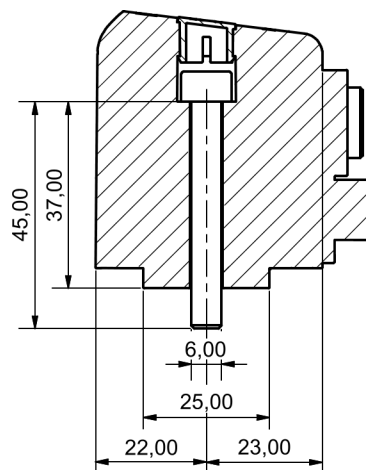

3.3 Installing the device directly on a component

If you require the SmartCheck device to be screwed directly onto a machine or component, the following prerequisites for the installation must be satisfied:

- The component must have a minimum wall thickness of 9 mm
- The installation surface must not be curved or uneven.
- The surface should exhibit a mean roughness index of $R_a = 3.2 \mu\text{m}$

Proceed as follows:

1. Prepare a circular, smooth and level installation surface with a minimum diameter of 25 mm.
2. Now drill an M6 hole at least 9 mm deep square to and in the centre of the installation surface.

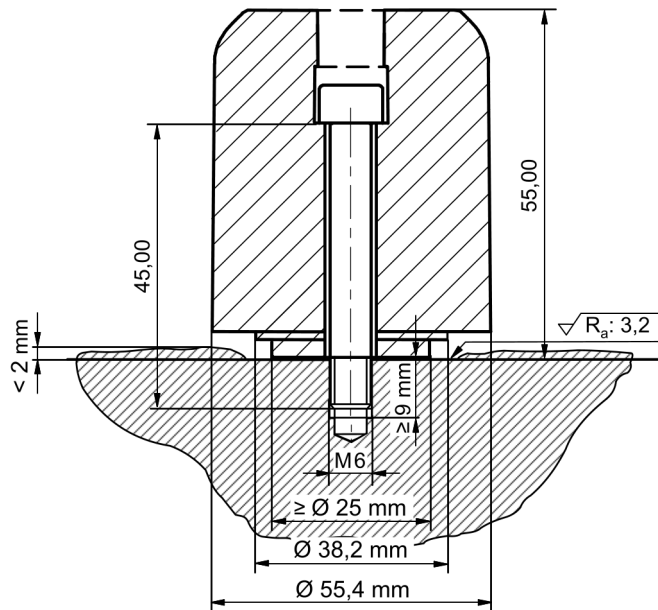

Detail drawing of device installed on a component

3. Clean the installation surface.
4. Apply a thin film of lubricant to the cleaned surface.
Adding lubricant will improve the transfer of vibrations.
5. Insert the M6x45 hex socket head fixing screw supplied into the SmartCheck mounting aperture.



- To prevent the screw from falling out during installation, you can secure it where necessary using an O-ring that is also included in the scope of delivery. Ensure that the O-ring does not slip between the installation surface and the sensor area during installation as this would impede vibration transfer and distort the measurement result.
- You can also use an optional screw locking compound (e.g. Loctite threadlock) to ensure the installation is permanent.

6. Align the sensor area of the SmartCheck device on the installation surface and hand-tighten the fixing screw using an offset screwdriver. Ensure that SmartCheck is sitting flat on the surface to ensure optimum vibration transfer.
7. Use a torque wrench to tighten and secure the connection to a tightening torque from 5 to 10 Nm.



To avoid damage, select the fixing screw and the torque setting in line with the material properties of both the installation point and the screw.

8. Check that FAG SmartCheck is seated securely.
9. Close the mounting aperture on the device by inserting the plug bearing the logo until it snaps in place.

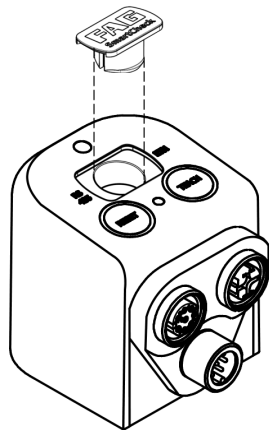

Mounting aperture with plug



The plug can be removed by inserting the blade of a flat-tip screwdriver under the bevels beside the logo and carefully levering it out.

You can now set up and connect  FAG SmartCheck.

3.4 Installing the device on a sensor mounting plate

If the SmartCheck device cannot be screwed directly onto a machine or component, you can bond an M6 sensor mounting plate onto the installation surface and then screw the device to the mounting plate. The M6 sensor mounting plate is available as an optional accessory from FAG Industrial Services GmbH. Please contact your customer support representative (see Support).

In order to install the device using a sensor mounting plate, the following prerequisites must be satisfied:

- The installation surface must not be curved or uneven.
- SmartCheck must be secured square to the installation surface
- The surface should exhibit a mean roughness index of $R_a = 3.2 \mu\text{m}$

Proceed as follows:

1. Prepare a circular, smooth and level installation surface with a minimum diameter of 25 mm.

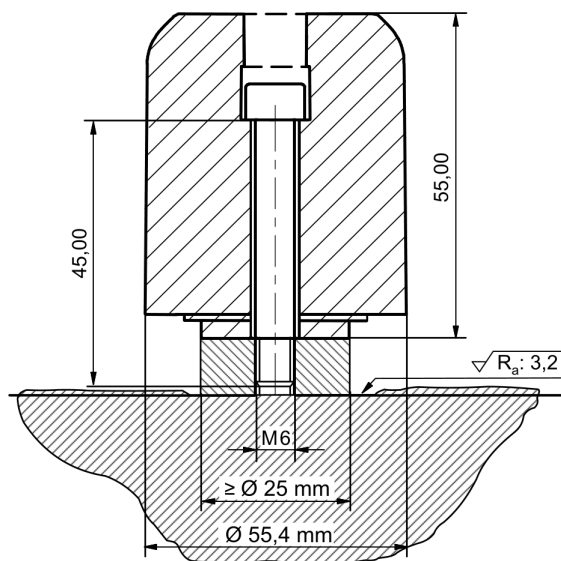

Detail drawing of device installed on a sensor mounting plate

2. Clean the installation surface.
3. Apply an adhesive that is suitable for vibration measurement to the surface (e.g. Loctite 330).



Please select an adhesive that is suitable for the installation site and the ambient conditions.

4. Position the sensor mounting plate on the adhesive and press it down firmly.
Wait until the adhesive has fully dried.
5. Clean the surface of the sensor mounting plate.
6. Apply a thin film of lubricant to the cleaned surface.
Adding lubricant will improve the transfer of vibrations.
7. Insert the M6x45 hex socket head fixing screw supplied into the SmartCheck mounting aperture.



- *To prevent the screw from falling out during installation, you can secure it where necessary using an O-ring that is also included in the scope of delivery. Ensure that the O-ring does not slip between the installation surface and the sensor area during installation as this would impede vibration transfer and distort the measurement result.*
- *You can also use an optional screw locking compound (e.g. Loctite threadlock) to ensure the installation is permanent.*

8. Align the sensor area of the SmartCheck device on the installation surface and hand-tighten the fixing screw using an offset screwdriver. Ensure that SmartCheck is sitting flat on the surface to ensure optimum vibration transfer.
6. Use a torque wrench to tighten and secure the connection to a tightening torque from 5 to 10 Nm.
9. Check that FAG SmartCheck is seated securely.
10. Close the mounting aperture on the device by inserting the plug bearing the logo until it snaps in place.

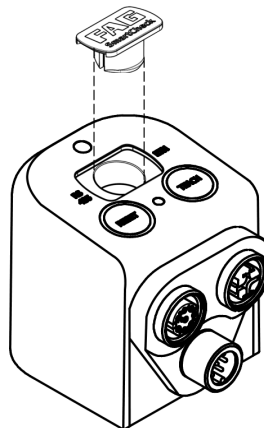

Mounting aperture with plug



The plug can be removed by inserting the blade of a flat-tip screwdriver under the bevels beside the logo and carefully levering it out.

You can now set up and connect [14](#) FAG SmartCheck.

4 Set-up

You can use the connections on the FAG SmartCheck device to

- Set up inputs and outputs [\[16\]](#) and various connection configurations
- Set up a PC/Ethernet connection [\[16\]](#) and
- Connect the power supply [\[17\]](#)

To set up and operate the SmartCheck device, you will need the following connection cables - these are not included in the standard scope of delivery:

- Input/output cables
- Ethernet connection cable (Ethernet/PoE)
- Power supply cable



- *The FAG SmartCheck device may only be prepared for use by persons who are verifiably qualified to do so in accordance with the relevant regulations.*
- *Ensure that the SmartCheck device is de-energised while set-up operations are being carried out.*

General

Please note the following information when connecting cables:

- Ensure that the sockets for the plug connections are clean and free from impurities. Dirt or moisture in plug connections can impair signal quality.
- When securing cables, ensure that they are not subjected to any mechanical strain. If necessary, fit strain relief accessories.
- Observe the minimum permissible bending radii for the cables. These can be found in the data sheets from the cable manufacturer. A minimum bending radius of 60 mm is recommended for cables from the standard range of accessories from FAG Industrial Services GmbH.
- Attach the cables in such a way that they are laid firmly and cannot be knocked.
- Do not lay signal cables parallel to high-power lines.

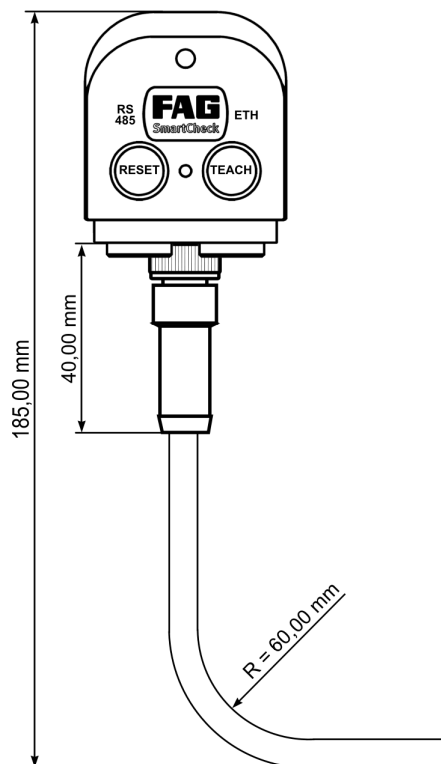

Example showing power supply cable from the standard range of accessories

4.1 Connection overview

In the following graphic you will find:

- A detailed circuit diagram with information concerning all of the connection options for the SmartCheck device, i.e. concerning the inputs and outputs [18], communication via Ethernet [25] and the power supply [25]
- An overview of the positions of plugs and sockets on the device
- An overview of the pin assignments for the plugs and sockets



Use standard cables to connect external sensors, control signals and the power supply to SmartCheck. These cables are available from FAG Industrial Services GmbH or from your supplier.

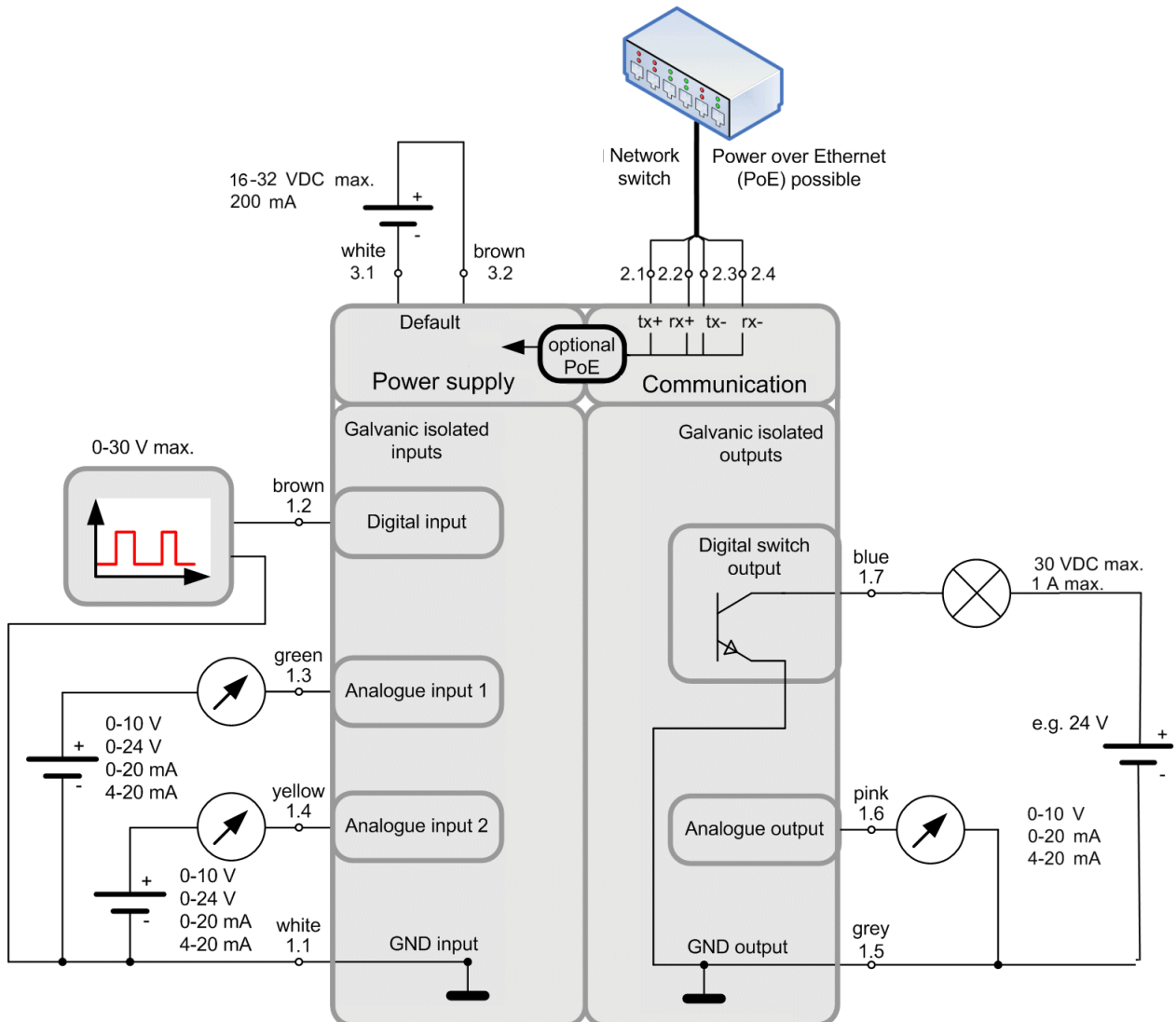
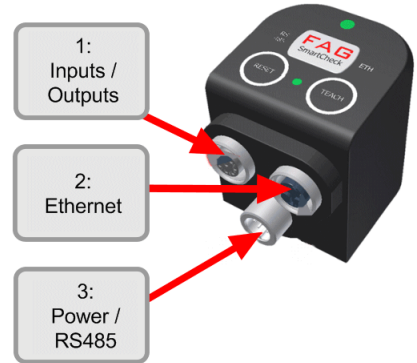
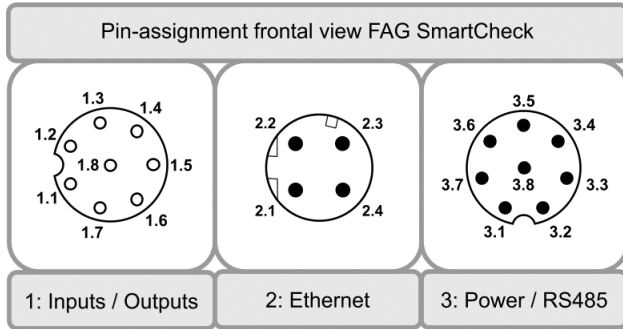



- The numbering of the connections corresponds to the numbering specified in the detailed information for each individual connection. You can find more information in the Connection details^[16] section.
- The information relating to the colours used in conjunction with the cable assignments refers to the cables in the optional range of accessories^[8] for FAG SmartCheck.

4.2 Connection details

Use the M12 connections on the SmartCheck device to connect the inputs and outputs^[16], the PC/Ethernet connection^[16] and the power supply^[17]:

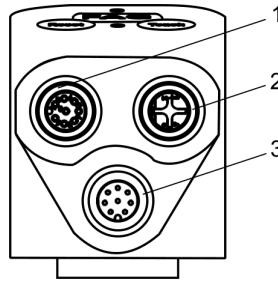

- **Connection 1:** Input/output socket
- **Connection 2:** Ethernet plug
- **Connection 3:** Power supply plug

Details on the assignment of the various cables required can be found in the sections below.



Cover any M12 connections that are not in use with the plugs supplied. This is the only way to ensure that the degree of protection is maintained.

Connection 1: Input and output socket

The inputs and outputs of the SmartCheck device can be connected using the top left socket.

The pins are defined as follows:

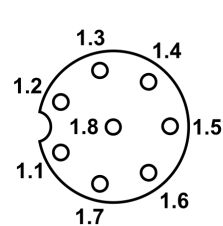
Pin assignment	No.	Signal	Colour*
 Front view of the device	1.1	GND inputs	White
	1.2	Digital input	Brown
	1.3	Analogue input 1	Green
	1.4	Analogue input 2	Yellow
	1.5	GND outputs	Grey
	1.6	Analogue output	Pink
	1.7	Digital output	Blue
	1.8	Not connected	Red

* Colours are for standard cables from the optional accessories for the FAG SmartCheck.

Connection 2: Ethernet plug

The Ethernet plug, which you can use to connect the SmartCheck device to your computer and to the Internet/Intranet, is located at the top right.

The pins are defined as follows:

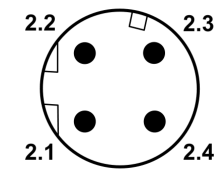
Pin assignment	No.	Signal	Colour*
 <p>Front view of the device</p>	2.1	TD+ transmission data	White/orange
	2.2	RD+ received data	White/green
	2.3	TD- transmission data	Orange
	2.4	RD- received data	Green

* Colours are for standard cables from the optional accessories for the FAG SmartCheck.

Connection 3: Power supply plug

The power supply plug on the SmartCheck device, including the supply to the real time clock (RTC), is below. This connection can also be used for RS485, e.g. to connect FAG SmartCheck to your machine controller or to other SmartCheck devices.



Communication via RS485 is not currently supported.

The pins are defined as follows:

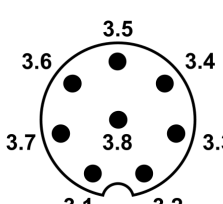
Pin assignment	No.	Signal	Colour*
 <p>Front view of the device</p>	3.1	Power supply, earth	White
	3.2	Power supply, positive	Brown
	3.3	RS 485+	Green
	3.4	RS 485-	Yellow
	3.5	Power supply, RTC, positive	Grey
	3.6	Power supply, RTC, earth	Pink
	3.7	Not connected	Blue
	3.8	Not connected	Red

* Colours are for standard cables from the optional accessories for the FAG SmartCheck.

RTC power supply

By default, the SmartCheck device's internal clock, the real time clock (RTC), is supplied with power by the device itself. This means that the clock is without current and that the time stops as soon as the device is switched off. You can prevent this by supplying the internal clock (RTC) with additional power via pins 5 and 6 of the power supply plug, e.g. by connecting it to a battery (min. 3 V) or an uninterruptible power supply (UPS) (see the graphic in the Cabling multiple devices [\[27\]](#) section).

This additional supply is not required if you refresh the time via an NTP server. To do this, the option "Use NTP server to synchronise system time" must be activated in the FAG SmartWeb software.

4.3 Connecting inputs and outputs

You have the option of using the SmartCheck device with two analogue inputs, one digital input, one analogue output or one digital output. To do this, you will need to create a cable connection and connect your external devices using the predefined cable assignment [16](#).

Proceed as follows:

1. Prepare the connection cable for the inputs and outputs.
2. Pick up the input/output cable.
3. Insert the plug into the input/output connection on the device (top left).

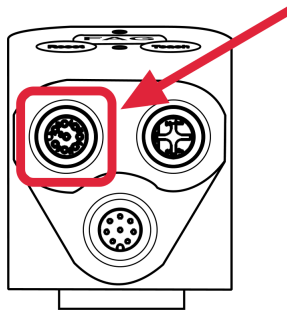

4. Lay the cable so as to connect it up to an external sensor or controller, for example. Refer to the general information [14](#) on laying cables.
5. Connect the cable.

An illustration of all the connection options for the SmartCheck device can be found in the Connection overview [15](#) section.

The following sections provide some detailed practical examples of input and output connections and their configuration in the FAG SmartWeb software. Further information can also be found in the FAG SmartWeb user documentation.

4.3.1 Connection configuration: Digital speed signal

This is how you connect a speed sensor to the FAG SmartCheck digital input:

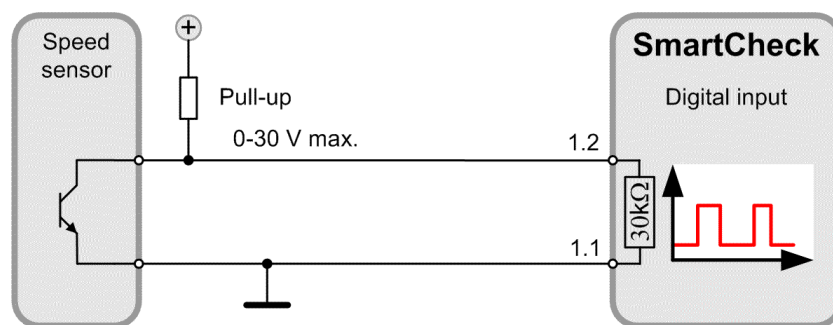

- The speed sensor must have a resistor (pull-up).
- When selecting the dropping resistor, please note the impedance of the input signal of your digital input. Note the maximum switching current of the digital switching output of the FAG SmartCheck device (1 A/30 V) and the power of the dropping resistor.
- If the speed sensor you are using only switches to earth (open-collector), you must provide another resistor for the supply line (pull-up).

You must also configure the digital input using the integrated FAG SmartWeb software. To do this, open the **Configuration > Input configurations > Digital input** field in the SmartWeb software. You can configure the

digital input using the **Edit**  button as follows, for example:

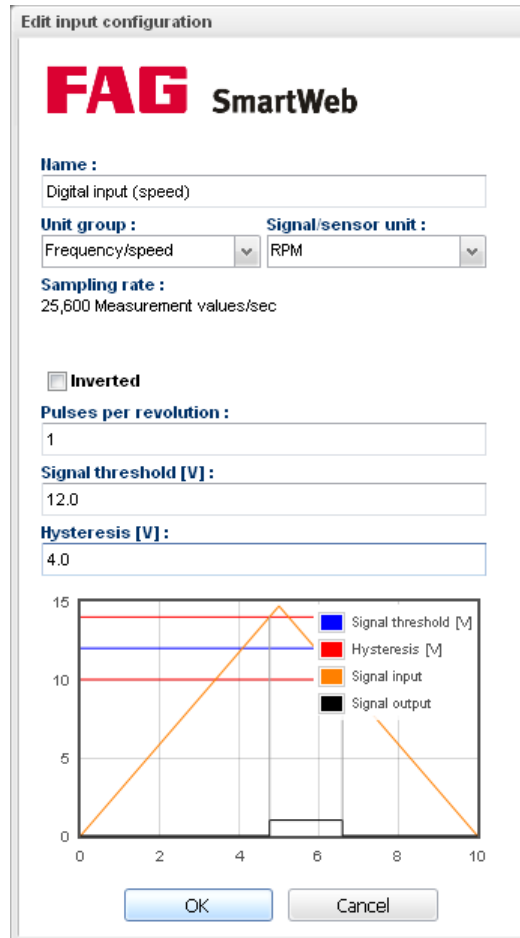

Details of the possible settings can be found in the FAG SmartWeb user documentation.



If you use the digital input and only generate one pulse per revolution and set this to measure the speed, you must make sure that the pulses have a minimum duration of 300 μ s.

Example:

You are using an optical sensor to measure the speed of your machine. You stick a reflective strip on the shaft to generate the pulses. This reflective strip must be long enough to generate pulses with a minimum duration of 300 μ s. If your machine is running at a maximum of **3000 rpm = 50 Hz**, you can calculate what percentage of the shaft circumference needs to be covered with the reflective strip as follows:

$$300 \mu\text{s} * 50 \text{ Hz} * 100\% \text{ (of the shaft circumference)} = 1.5\%$$

You therefore need to cover 1.5% of the shaft circumference with the reflective strip to obtain a minimum pulse duration of 300 μ s. For a shaft with a circumference of 1 m (approx. diameter 32 cm), the calculation is as follows:

$$1 \text{ m} * 1.5\% = 1.5 \text{ cm}$$

The reflective strip for a shaft with a circumference of 1 m running at a speed of max. 3000 rpm must therefore be at least 1.5 cm long.

4.3.2 Connection configuration: Analogue speed signal

You can connect a speed signal for a motor controller or a programmable logic controller (PLC) to the analogue input of the SmartCheck device. Details of both options can be found in the sections below.

Analogue speed signal from motor controller

This is how you connect a motor controller to the FAG SmartCheck analogue input; in our example, the motor controller delivers a speed signal of 0-3000 rpm with 0-10 V:

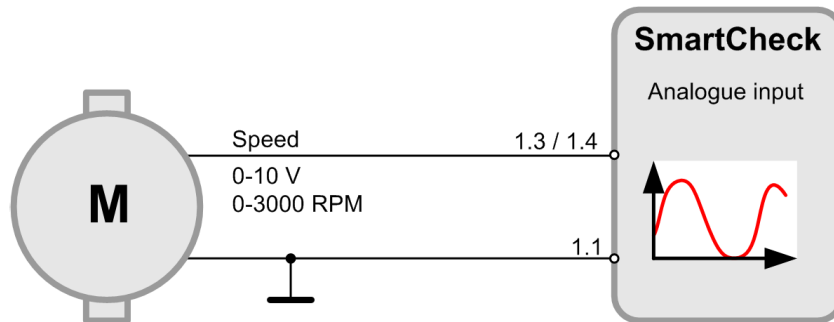

You must also configure the analogue input using the integrated FAG SmartWeb software. To do this, open the **Configuration > Input configurations > Analogue input 1** area in the SmartWeb software. You can configure the digital input using the **Edit**  button as follows, for example:

The screenshot shows the 'Edit input configuration' window in FAG SmartWeb. The settings are as follows:

- Name: Analogue input
- Unit group: Frequency/speed
- Signal/sensor unit: RPM
- Sampling rate: 1,280.0 Measurement values/sec
- Input type: 0 to 10 V
- Max: 3000 RPM
- Scaling: 300.0
- Min: 0.0

A graph shows the scaling from 0 to 10 V to 0 to 3000 RPM.

Details of the possible settings can be found in the FAG SmartWeb user documentation.

Analogue speed signal from programmable logic controller (PLC)

This is how you connect a PLC, e.g. a machine controller, to the analogue input of FAG SmartCheck; in our example, the PLC delivers an analogue speed signal of 0-3000 rpm with 4-20 mA:

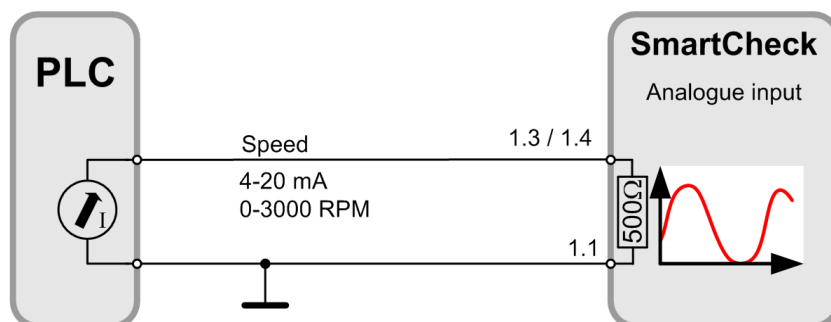

The analogue input of the SmartCheck device has a 500 ohm resistance when used as a current input.

You must also configure the analogue input using the integrated SmartWeb web application. To do this, open the **Configuration > Input configurations > Analogue input 1** area in the SmartWeb software. You can configure the digital input using the **Edit**  button as follows, for example:

The screenshot shows the 'Edit input configuration' dialog box in the FAG SmartWeb application. The configuration is as follows:

- Name:** Analogue input
- Unit group:** Frequency/speed
- Signal/sensor unit:** RPM
- Sampling rate:** 1,280.0 Measurement values/sec
- Input type:** 4 to 20 mA
- Max:** 3000 RPM
- Scaling:** 187.5
- Min:** 0.0

A graph displays a linear relationship between current (mA) on the x-axis (0 to 20) and speed (RPM) on the y-axis (0 to 3000). The line starts at (0, 0) and ends at (20, 3000). The 'OK' and 'Cancel' buttons are visible at the bottom.

Details of the possible settings can be found in the FAG SmartWeb user documentation.

4.3.3 Connection configuration: Analogue output signal

This is how you connect a PLC, e.g. a machine controller, to the FAG SmartCheck analogue output. In our example, the SmartCheck device delivers an analogue output signal to a PLC with 4-20 mA.

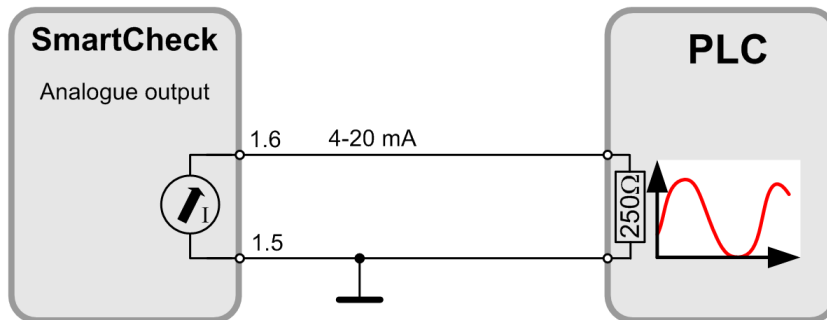

- Ensure that the input of the PLC is connected to a resistor of max. 250 Ohm.
- The analogue output is deactivated if it is overloaded by excessive current. To activate the analogue output, restart the SmartCheck device or briefly interrupt the power supply to the SmartCheck device.

You must also configure the analogue output using the integrated FAG SmartWeb software. To do this, open the **Configuration > Output configurations > Analogue output** field in the SmartWeb software. You can configure the digital input using the **Edit**  button as follows, for example:

Alarm	Output
no alarm	4 mA
pre-alarm	12 mA
main alarm	20 mA

Details of the possible settings can be found in the FAG SmartWeb user documentation.

4.3.4 Connection configuration: Digital output signal

You can supply a digital output signal to a relay or a PLC via the FAG SmartCheck digital output. Details of both options can be found in the sections below.

Digital output signal to relay

For this option, the SmartCheck device provides a digital open-collector output that can switch a relay against positive. Our example shows how to switch a 24-V relay against the open collector:

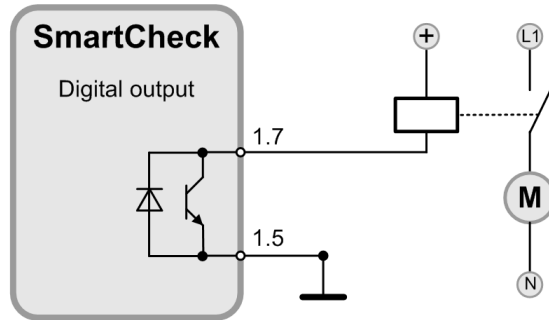

You must also create the digital output using the integrated FAG SmartWeb software. To do this, open the **Configuration > Output configurations** field in the SmartWeb software. You can use the **Add +** button to add a digital output and configure it as follows, for example:

FAG SmartWeb

Add output configuration

Name :
Device overall status

Output channel :
Digital output

Characteristic value configuration :
Overall alarm status

Output type :
 Alarm output
 Characteristic value output

Inverted

Alarm limit :
pre-alarm

Alarm	Output
no alarm	off (open/pull-up)
pre-alarm	on (closed/earth)
main alarm	on (closed/earth)

Details of the possible settings can be found in the FAG SmartWeb user documentation.

Digital output signal to PLC

With this option, the SmartCheck device supplies a digital output signal to a PLC.

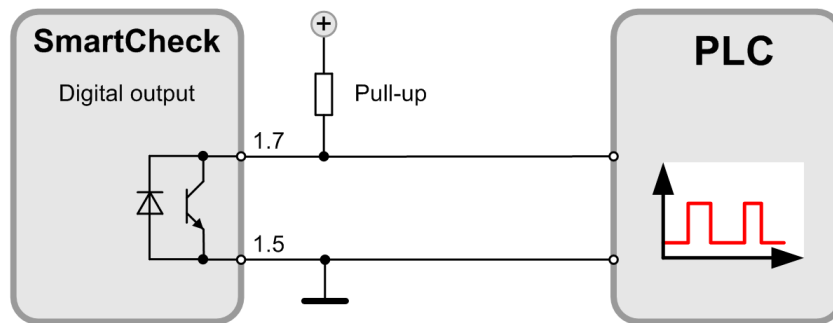

The line should be connected to a suitable pull-up resistor.

You must also create the digital output using the integrated SmartWeb web application. To do this, open the **Configuration > Output configurations** field in the SmartWeb software. You can use the **Add +** button to add a digital output and configure it as follows, for example:

The screenshot shows the 'Add output configuration' dialog box in the FAG SmartWeb software. The dialog contains the following fields and options:

- Name :** Device overall status
- Output channel :** Digital output
- Characteristic value configuration :** Overall alarm status
- Output type :** Alarm output (selected), Characteristic value output
- Inverted :**
- Alarm limit :** pre-alarm
- Alarm Output table:**

Alarm	Output
no alarm	off (open/pull-up)
pre-alarm	on (closed/earth)
main alarm	on (closed/earth)

Buttons: OK, Cancel

Details of the possible settings can be found in the FAG SmartWeb user documentation.

4.4 Connecting PC/Ethernet

In order to view measurement data from the SmartCheck device, download data or manage SmartCheck settings, you must connect the device to your PC via Ethernet. You can then call up and manage the SmartCheck device in a browser using the dedicated SmartWeb software.



The following basic prerequisites apply for connecting to the computer:

- *The UDP communication protocol must be enabled on ports 19000 and 19001 in existing firewalls in your network (this only applies when calling up the device using the SmartUtility software).*
- *If no address was assigned to the SmartCheck device via DHCP, it has the default IP address 192.168.1.100. In this case, the IP address of your computer must be within the 192.168.1.x range.*

Please contact your system administrator if you experience problems with the network settings.

To establish the connection, proceed as follows:

1. Prepare the Ethernet connection cable.
2. Pick up the Ethernet cable.
3. Insert the plug into the Ethernet port (top right).

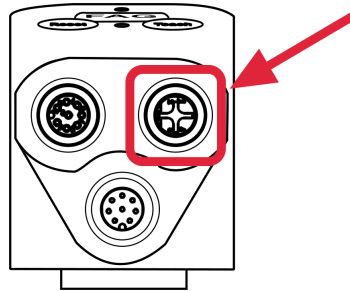

4. You can now establish a short-term connection, e.g. to a notebook. Refer to the general information [14](#) on laying cables.
5. Connect the cable to your Ethernet infrastructure or directly to your PC.

An illustration of all the connection options for the SmartCheck device can be found in the Connection overview [15](#) section.

4.5 Connecting the power supply



The SmartCheck device is ready for measurement as soon as the power supply is connected. To ensure optimum vibration monitoring from the outset, we recommend that you do not start the SmartCheck device until

- *All connections have been correctly made, and*
- *The machine to be monitored is in a normal operating state*

You can supply power to the SmartCheck device using either the power plug (power) or the Ethernet plug (Power over Ethernet). Relevant details can be found in the following sections.

DANGER**Damage to the SmartCheck device from unsuitable power supply!**

- Only use a power supply that meets the specifications set out in the [Technical data](#) ⁷ section as well as the relevant and applicable statutory requirements governing such components.
- When connecting the device, you must ensure the polarity is correct. Incorrect polarity can damage the device.
- Ensure that the connecting wires are installed with no voltage!

Supplying power using the power plug (power)

1. Prepare the power supply connection cable.
2. Pick up the power supply cable.
3. Insert the plug into the bottom socket for the power supply (see below).

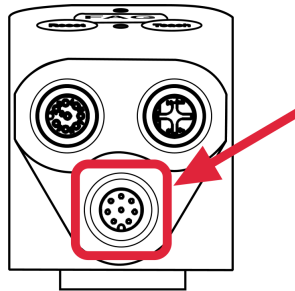

4. Lay the cable to the supply unit. Refer to the general information ¹⁴ on laying cables.
5. Connect the cable to the supply unit. For connected loads, please refer to the [Technical data](#) ⁷.

Details on the assignment of the cable can be found under [Connection details](#) ¹⁶.

An illustration of all the connection options for the SmartCheck device can be found in the [Connection overview](#) ¹⁵ section.

Supplying power using the Ethernet plug (PoE)

You can also supply FAG SmartCheck with power using the Ethernet connection (Power over Ethernet). To do this, you must first connect the SmartCheck device with a network switch that matches connected devices in accordance with IEEE Standard 802.3af Type A "Power over Ethernet" and that supports a phantom supply. This means that the power supply must be fed over the 4 signal leads. The following network switches are supported: NETGEAR FS752TP, NETGEAR GS724TP, NETGEAR FS108P, NETGEAR GS110TP.

To do this, proceed as follows:

1. Prepare the Power over Ethernet connection cable.
2. Pick up the Ethernet cable.
3. Insert the plug into the Ethernet port (top right).

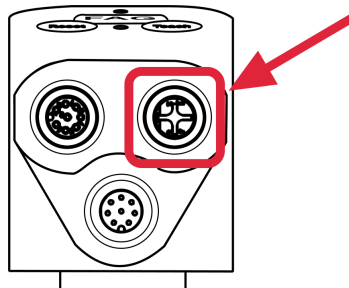

4. Lay the cable to the network switch. Refer to the general information ¹⁴ on laying cables when doing so.
5. Connect the cable to the network switch.

Details on the assignment of the cable can be found under Connection details [16](#).

An illustration of all the connection options for the SmartCheck device can be found in the Connection overview [15](#) section.



When disconnecting the power supply from the network switch, we recommend that you also disconnect the Ethernet connection from the SmartCheck device.

4.6 Connecting multiple devices

If you wish to install multiple SmartCheck devices, you can use M12 Y-splitters to connect the devices to the power supply and significantly reduce the length of cable required. The following illustrations provide an overview of the wiring for two basic applications:

- Connecting devices to the power supply **WITHOUT** a separate supply for the internal clock (RTC)
- Connecting devices to the power supply **AND** connecting a separate supply for the internal clock (RTC)



- We recommend using Y-splitters; these can be obtained from FAG Industrial Services GmbH.
- Please scale the power supply according to the number of connected devices and external consumers. Each SmartCheck device consumes max. 200 mA at 24 V.
- The regular power supply and the PoE must not be used simultaneously to supply multiple SmartCheck devices.

Power supply connection for multiple SmartCheck devices

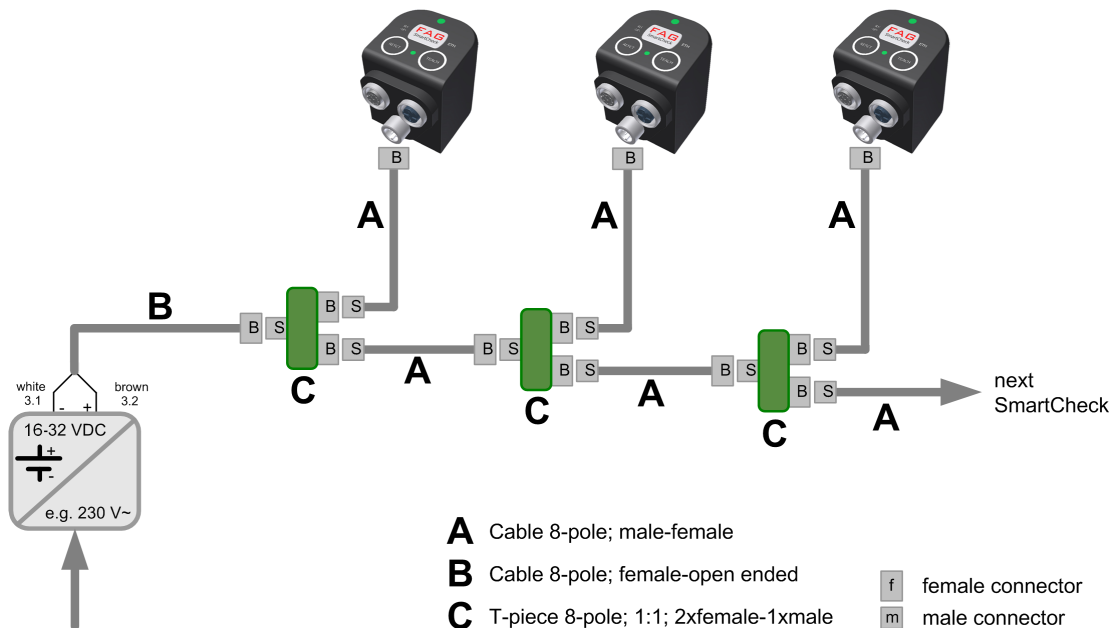

5 Operation and controls

You can operate the SmartCheck device using the buttons on the top of the device. Settings for the FAG SmartCheck device can only be made using the integrated SmartWeb web application. Details of this can be found in your SmartWeb user documentation.



The key lock is activated by default as of SmartCheck firmware version 1.4.26 to protect against inadvertent operation (see Deactivating the key lock [↗](#)). You can also use the SmartWeb software to specify which actions are allowed with these keys. Further information can be found in the SmartWeb user documentation in the section headed "Key settings".

Operation

Once you have assembled the SmartCheck device and supplied it with power, the SmartCheck device will start up. As soon as the device is ready to measure, the internal sensors—the vibration sensor and temperature sensor—will deliver signals. The basic measurement job already created in the factory default settings converts these signals into the following characteristic values:

- ISO 10816
- RMS broad band acceleration
- RMS broad band demodulation
- Peak-to-peak
- Temperature



If the machine you wish to monitor is not in a normal operating state, the SmartCheck device may issue an alarm after starting up.

Controls

All controls on the SmartCheck device are located on the top of the device. Here you will find two buttons and a total of four LEDs — the functions of these LEDs are described in more detail in the following sections.

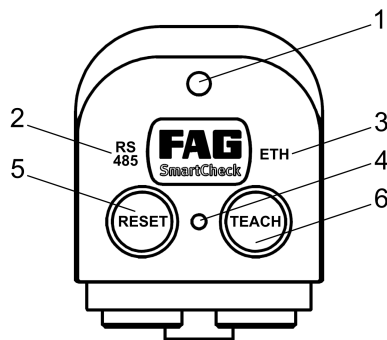

Item	Description	LED colour	Meaning
1	Status LED	Green, yellow, red	Indicates that the machine is ready to measure and the status of alarms, learning mode and firmware updates
2	"RS485" LED	Blue	Lights up on connection to the RS485 network (not currently supported)
3	"ETH" LED	Blue	Lights up on connection to the Ethernet network
4	Key-press LED	Green	Lights up when a button is pressed (only when the key lock is deactivated)
5	"Reset" button	-	Reset alarms; restart device; restore device to factory settings (when used in combination with the Teach button)
6	"Teach" button	-	Start learning mode; restore device to factory settings (when used in combination with the Reset button)

Status LED

The status LED is located above the fixing screw cover (item 1):

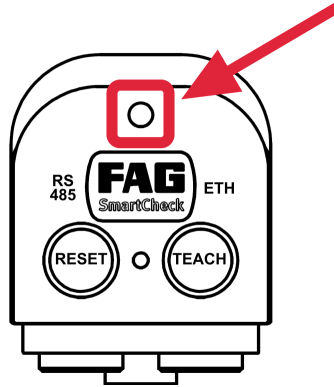

The LED behaves differently depending on whether you have only just switched on the SmartCheck device or whether it has already started up. Relevant details can be found in the following sections.

Status LED immediately after switching on the device

Once the device is switched on, the LED alternates between red and yellow. Do not disconnect the device from the power supply during this phase. Once the start-up process is complete, the status LED indicates the current alarm status.

Status LED after starting up

Once the device has started up, the status LED changes from flashing red to yellow to green. The LED then lights up as follows depending on the status of SmartCheck:

LED	Meaning
Green	SmartCheck is ready to measure without alarm.
Yellow	SmartCheck is ready to measure with pre-alarm.
Red	SmartCheck is ready to measure with main alarm.
Flashing (green)	At least one of the characteristic values is still in learning mode.
Alternating red and yellow	This signals one of the following conditions: <ul style="list-style-type: none">• The device is in the Maintenance System (maintenance mode).• The firmware is resetting.• A firmware update is in progress.• The device is (re)starting.



You can use the SmartWeb software to specify that the status LED should not indicate the alarm status. This setting remains in force when the device is reset unless the device is reset to the factory default settings: in this case, the alarm status display is reactivated.

RS485 LED

The **RS485** LED is located to the left of the fixing screw cover (item 2):

This LED lights up blue when SmartCheck is connected to the RS485 network. It flashes when data is being exchanged.



Communication via RS485 is not currently supported.

ETH LED

The **ETH** LED is located to the right of the fixing screw cover (item 3):

This LED lights up blue when the SmartCheck device is connected to the Ethernet network. It flashes when data is being exchanged.

LED between the buttons

Another LED is located between the Reset and Teach buttons (item 4); this LED acknowledges when you press a button:

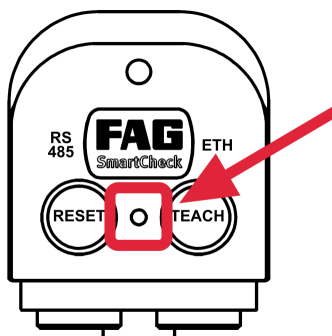

When the key lock  is deactivated, this LED lights up in green as soon as you press one of the capacitive keys. It stays on until you interrupt contact with the button.

A description of the Reset and Teach button functions can be found in the next section.

5.1 Reset and Teach buttons



- Before pressing any buttons, please ensure that the device has started up correctly (observe the status LED after switching on ).
- The key lock is activated by default on the SmartCheck device as of firmware version 1.4.26.
- You can also go to **Device settings > Key settings** in the FAG SmartWeb software to specify the actions permitted using these keys. In this way, you protect the <SmartCheck/> device against inadvertent operation. For more information, please see the handbook for the FAG SmartWeb software.

Deactivating the key lock

If you want to operate the keys on the SmartCheck device, you must first deactivate the key lock. Press the Reset key and then press the Teach key within 2 seconds. The LED between the keys (item 4) flashes to confirm.

After 2 minutes, the key lock is automatically reactivated. The LED between the keys then goes out again.

RESET button

Which function the Reset button executes will depend on how long you press and hold it:

- If you press and hold the Reset button for **longer than 2 seconds**, you will reset the current alarms
- If you press and hold the Reset button for **longer than 10 seconds**, you will restart the SmartCheck device.

TEACH button

If you press and hold the Teach button for **longer than 5 seconds**, the learning mode will be restarted for all measurement jobs that use learning mode.

Further information on the learning mode can be found in the user documentation for the SmartWeb web application.

Restoring factory settings

CAUTION



Measurement data and configurations will be irretrievably deleted!

If you restore the FAG SmartCheck device to its factory settings, you will lose all measurement data and configurations stored in the device!

Before resetting the device, download the measurement data using the FAG SmartUtility Light software. The full version of FAG SmartUtility also allows you to download the configuration of the SmartCheck device.

You can restore the FAG SmartCheck device to its factory settings using both buttons. To do this, the device must be

fully started and be ready to measure (observe the status LED after switching on ). Then press the Reset button and the Teach button together at the same time and hold for longer than 10 seconds. The device will be restored to its factory default settings.

You must now install new firmware, if applicable. Further information can be found in the user documentation for FAG SmartUtility Light or FAG SmartUtility.

6 Further information

Viewing the signal in the browser for the first time

Once the FAG SmartCheck vibration monitoring system has started up and is in measuring mode, you can view the measurement data using the FAG SmartWeb software on your PC. This allows you to check whether a valid vibration or temperature signal is being received, whether you have connected and configured the inputs correctly and whether the SmartCheck device is operating properly.



The following basic prerequisites apply for connecting to the computer:

- The SmartCheck device must be on the network or directly connected to your computer via Ethernet cable.
- If no address was assigned to the SmartCheck device via DHCP, it has the default IP address 192.168.1.100. In this case, the IP address of your computer must be within the 192.168.1.x range.

For more information, please see the section entitled **First start-up** in the handbook for the SmartWeb software. Please contact your system administrator if you experience problems with the network settings.

Proceed as follows:

- Open a browser (e.g. Mozilla Firefox) and
- Enter the IP address of the SmartCheck device in the address line.

The FAG SmartWeb web application opens.

The screenshot displays the FAG SmartWeb web application interface. At the top, the browser window shows the URL 'http://192.168.1.100'. The application header includes the FAG logo and 'SmartWeb' text, along with connection status 'Connected to: FAG SmartCheck' and 'Logged in as: admin'. The main interface is divided into several sections:

- Left Navigation Panel:** Contains 'Status', 'Actions' (with links for 'Create new measurement job' and 'Show measurement jobs'), 'Areas', and a list of monitoring parameters such as 'Crest factor', 'ISO 10816-1', 'Peak-peak', 'Periodic value', 'RMS broad band', 'Temperature', and 'Welhausen counter'.
- Main Content Area:**
 - Characteristic value status:** Shows 'Name: Standard measuring job', 'Current alarm status: no alarm', and 'Last measurement: 2011-10-11 11:06:01'. Below this is a horizontal bar chart showing data over time from 2011-10-07 to 2011-10-11.
 - System information:** Lists various system metrics:

Last config change:	2011-07-14 10:06:51	Vibration sensor:	0.004286 g (Acceleration)
Last measurement:	2011-10-11 11:14:02	Temperature sensor:	39.0 °C (Temperature)
System start time:	2011-10-10 11:07:49	Voltage:	9.0633 V (Voltage)
Free memory capacity:	54.414 MB of 70.246 MB free	Load:	99.993 % (Load)
		Digital input (pulses):	- (No unit)
		Digital input (speed):	- RPM (Frequency/speed)
 - Logbook:** A table showing system events:

Category	Created	Modified	User	Message
Information	2011-10-11 11:06:08	2011-10-11 11:06:08	system	Standard measuring job: Alarm status changed from "Pre-alarm" to "No alarm".
Information	2011-10-11 11:04:15	2011-10-11 11:04:15	system	User admin logged in via 172.28.204.146
Information	2011-10-11 09:53:54	2011-10-11 09:53:54	system	Standard measuring job: Alarm status changed from "Main alarm" to "Pre-alarm".
Information	2011-10-11 09:52:01	2011-10-11 09:52:01	system	Standard measuring job: Alarm status changed from "Pre-alarm" to "Main alarm".
Information	2011-10-11 09:02:51	2011-10-11 09:02:51	system	Standard measuring job: Alarm status changed from "Main alarm" to "Pre-alarm".
Information	2011-10-11 09:00:57	2011-10-11 09:00:57	system	Standard measuring job: Alarm status changed from "Pre-alarm" to "Main alarm".
Information	2011-10-11 08:42:17	2011-10-11 08:42:17	system	Standard measuring job: Alarm status changed from "No alarm" to "Pre-alarm".

Start screen of the FAG SmartWeb software



To change the software language, in the **Edit** menu select **Edit program settings** > **Language**. Select the required language from the list and click **OK**. Refresh the page in your browser to activate the changes.

- In the left-hand pane, click the **Live view** button.

Here you can view the relevant signal for each input and the scaling factors created for them.

- For example, select the **Vibration sensor** input from the menu on the left.

If you have connected the SmartCheck device correctly, you will see the signals of the vibration sensor/the selected signal input in the **Live view** area.

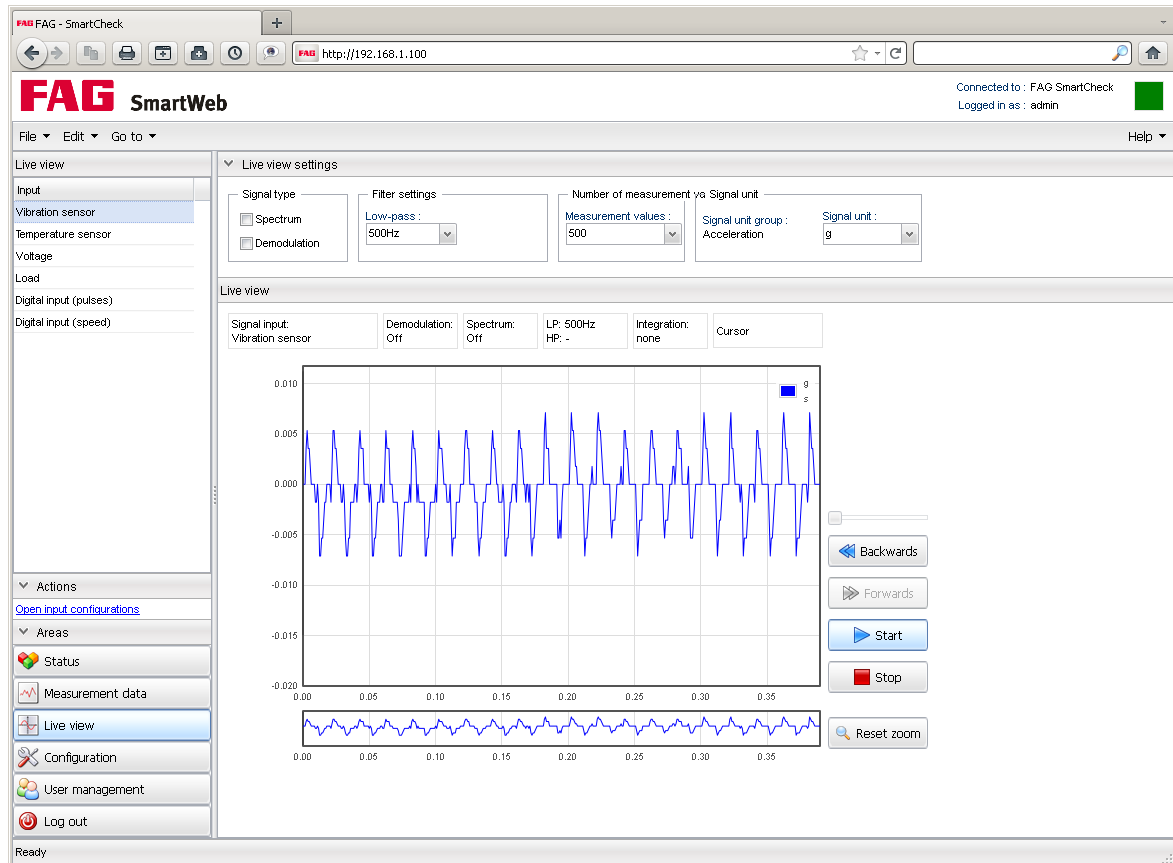

Live view in the FAG SmartWeb software

Detailed instructions for configuring the FAG SmartCheck device and for analysing the measurement data can be found in the user documentation for FAG SmartWeb and FAG SmartUtility Light or FAG SmartUtility. This documentation can be found on the supplied CD ROM.

Information and services relating to FAG SmartCheck

We offer a unique range of services for FAG SmartCheck — from training courses, technical mentoring during the induction phase and expert support with diagnostic issues, right through to customised service agreements including remote monitoring and reporting.

A selection of our comprehensive range of products and services for FAG SmartCheck can be found on the Internet at www.FAG-SmartCheck.com.

7 Maintenance and repair

The SmartCheck device is a closed, embedded system and as such is essentially maintenance free. Should you detect a fault with the SmartCheck device, please contact our Support team.

Cleaning

You can clean the outside of the device if necessary.

- Disconnect the device from the mains.
- Clean the device using a clean, lint-free cloth.

CAUTION**Damage to the device from improper handling!**

Do not use chemical solvents such as acetone, nitro thinners or similar products as these solvents may damage the device housing.

8 Decommissioning and disposal

Decommissioning

If the SmartCheck can no longer be operated safely, the device must be decommissioned and secured against inadvertent operation. The device can no longer be operated safely if it:

- Exhibits visible signs of damage
- Ceases to function
- Has been stored under damaging conditions
- Has been exposed to severe stresses in transit

Disposal

The SmartCheck and its associated components must not be disposed of as household waste as they contain electronic components that must be disposed of in the appropriate manner. Please return the device and/or components to us so that we can ensure they are disposed of in an environmentally friendly manner and in accordance with the relevant regulations. By returning old devices, you will be making an important contribution to protecting our environment.

9 Manufacturer / Support

Manufacturer

FAG Industrial Services GmbH

Kaiserstraße 100
52134 Herzogenrath
Germany

Tel.: +49 (0) 2407 9149-66
Fax: +49 (0) 2407 9149-59
Support: +49 (0) 2407 9149-99

Website: www.schaeffler.com/services
For more information: www.FAG-SmartCheck.com
Contact: industrial-services@schaeffler.com

Please send all correspondence directly to FAG Industrial Services GmbH!

A subsidiary of

Schaeffler Technologies AG & Co. KG

PO Box 1260
97419 Schweinfurt
Germany

Georg-Schäfer-Straße 30
97421 Schweinfurt
Germany

Support

Tel.: +49 (0) 2407 9149 99
Email: support.is@schaeffler.com

We provide support services for the FAG SmartCheck device and related software products. A detailed description of the type and scope of the support services we provide can be found online at www.FAG-SmartCheck.com.

10 Appendix

EC conformity declaration

The manufacturer

**FAG Industrial Services GmbH, Kaiserstraße 100,
52134 Herzogenrath, Germany**

hereby declares that the product

FAG SmartCheck
(from serial number F43D80000000)

meets the protection requirements specified in the guidelines on Electromagnetic Compatibility Directive (2004/108/EC), provided that the product has been professionally and correctly installed in accordance with the commissioning instructions of this manual.

The following standards, among others, were referred to when assessing the product:

EN 61326-1:2006
EN 61326-2-3:2006
EN 55011:2009 + A1:2010 Class A
EN 61000-4-2:2009
EN 61000-4-3:2006 + A1:2008 + A2:2010
EN 61000-4-4:2004 + A1:2010
EN 61000-4-5:2006
EN 61000-4-6:2007

Measuring device mark: **CE**

Herzogenrath, 2011-10-04



Dipl.-Ing. Armin Kempkes
Managing Director

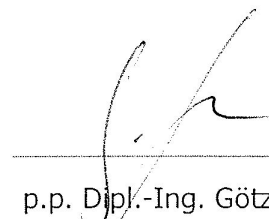

p.p. Dipl.-Ing. Götz Langer
Head of Development

SCHAEFFLER

